

IM R SERIES

TRACK DRIVEN CRAWLER ACCESS PLATFORMS | INDOOR / OUTDOOR



IM R 13 T



TELESCOPIC

SOSEQUIMENT

VENTE | LOCATION | SERVICE | TRANSPORT
1-833-360-3330 | INFO@SOSEQUIMENT.CA

PERFORMANCE

Platform Height 36'
Working Height 42'

STANDARD EQUIPMENT

- Automatic outrigger leveling system
- 120V, 15 amp electric motor for indoor use
- Air / Water outlet in the platform basket
- 120V AC power to platform
- Removable wireless control box
- Tether for wired connectivity
- Emergency hand pump
- Cylinder holding valve
- Hour meter
- Load and tip detection sensor
- Load cell
- Hydraulic jib
- Rubber tracks
- Three travel speeds
- Remote battery charger
- Removable basket with 1 pin detach
- Overload sensor
- 120V battery charger
- Proportional controls with diagnostics
- Honda GX390 Engine
- Hydraulic basket rotation - 124°

- ✓ Portable / removable wireless control box allows operator to drive from the ground level
- ✓ Active jib allows for a range of motivation up and down
- ✓ Electro-hydraulic controls: efficiency and safety for the operators
- ✓ Compact overall sizes and reduced stabilization footprint

- ✓ Four telescopic arms for max upward and outward reach
- ✓ Load and tip detection sensor for maximum safety and performance

42'
working height

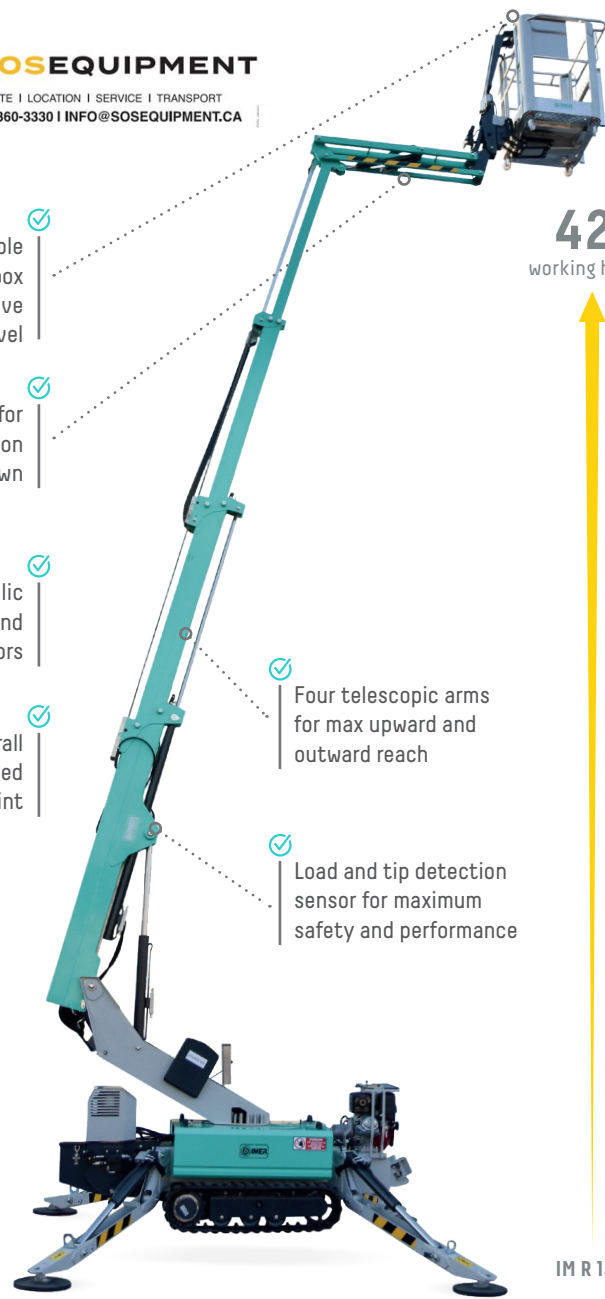

IM R 13 T

OPTIONAL EQUIPMENT

- Non-marking rubber tracks
- Working light in the platform basket
- 12 V emergency pump
- 120 V desktop remote charge
- Sliding & oversized outrigger pads
- IMERVIEW GPS Remote Monitor System



Compact 31" width allows access in narrow, hard to reach places



Easy access both outdoor and indoor. Non-marking tracks for indoor use



File:1128728 - IMER Access Sell Sheets - IM R 13

IM R SERIES

TRACK DRIVEN CRAWLER ACCESS PLATFORMS | INDOOR / OUTDOOR



This machine meets or exceeds applicable ANSI and CSA requirements based on machine configuration as originally manufactured for intended applications. Reference the serial number plate on the machine for additional information.



SOSEQUIMENT

VENTE | LOCATION | SERVICE | TRANSPORT
1-833-360-3330 | INFO@SOSEQUIMENT.CA



FAST & SECURE LEVELING
Automatic outrigger leveling system for quick set up and peace of mind.



EASY USER EXPERIENCE
A user-friendly control panel, easily removable wireless remote control allows for more space in the basket and navigation from the ground.

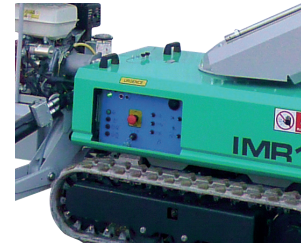

EASY ACCESS
In addition to the removable control box in the basket, the IM R Series includes an easy to access ground control panel.

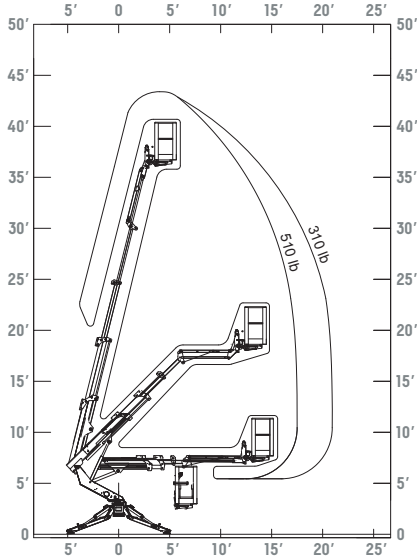

ADJUSTABLE TRACKS
Hydraulically adjust the track width for added stability and traction, and to fit through narrow doorways and gates for interior or exterior projects

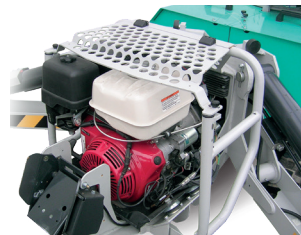

BI-ENERGY POWER
A Honda Engine and Electric Motor provide a bi-energy solution, allowing both indoor and outdoor use (shown with a rugged engine guard for improved protection)



SUPERIOR ROTATION
Outstanding accessibility with a 355° rotation (non-continuous) and 124° jib rotation

		IM R 13 T
Working height	ft	42'
Platform height	ft	36'
Side outreach (weight in basket)	ft / lb	17' / 510 - 20' 6" / 308
Rotation (non-continuous)	deg	355°
Basket dimensions	in	51" x 28" x 43"
Basket rotation	deg	355°
Transport length (without basket)	ft	12' 4" / 9' 8"
Transport width (without basket)	ft	Max 4' 3" / Min 2' 6"
Height in stowed position	ft	Min 6' 6 3/4" / Max 6' 11"
Overall outrigger footprint	ft	8' 8" / 9' 2"
Stabilizer load	ft-lb	2496
Driving speed	mph	0 - 1
Gradeability	%	30%
Platform capacity	lb	510
Gas motor		Honda GX390
Machine weight	lb	3410

*w/ stabilizers in position

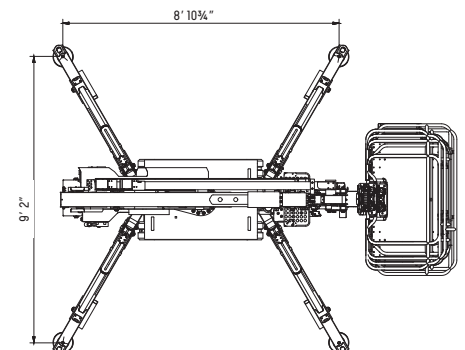
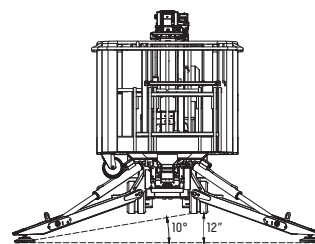
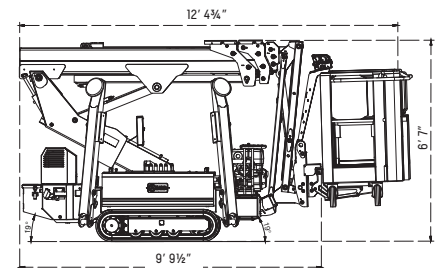
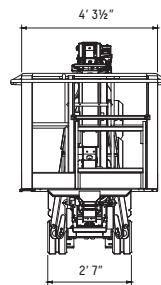

File:1128728 - IMER Access Sell Sheets - IM R 13